

RU

ИНСТРУКЦИЯ ПО УСТАНОВКЕ
ЗАЩИТЫ КАРТЕРА

GB

INSTALLATION MANUAL
SKID PLATE FOR ENGINE BAY



TOYOTA LAND CRUISER 300 3,5 AT FULL WD

2021 - 

24.5033/24.5034

28/10/21

1/7



RU Позиция/Расположение
GB Location/Position Arrow

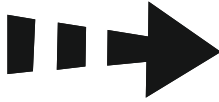





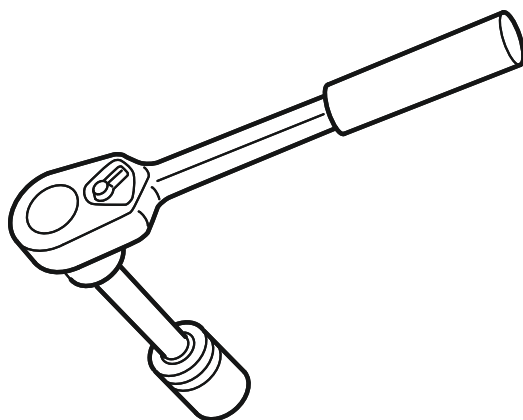
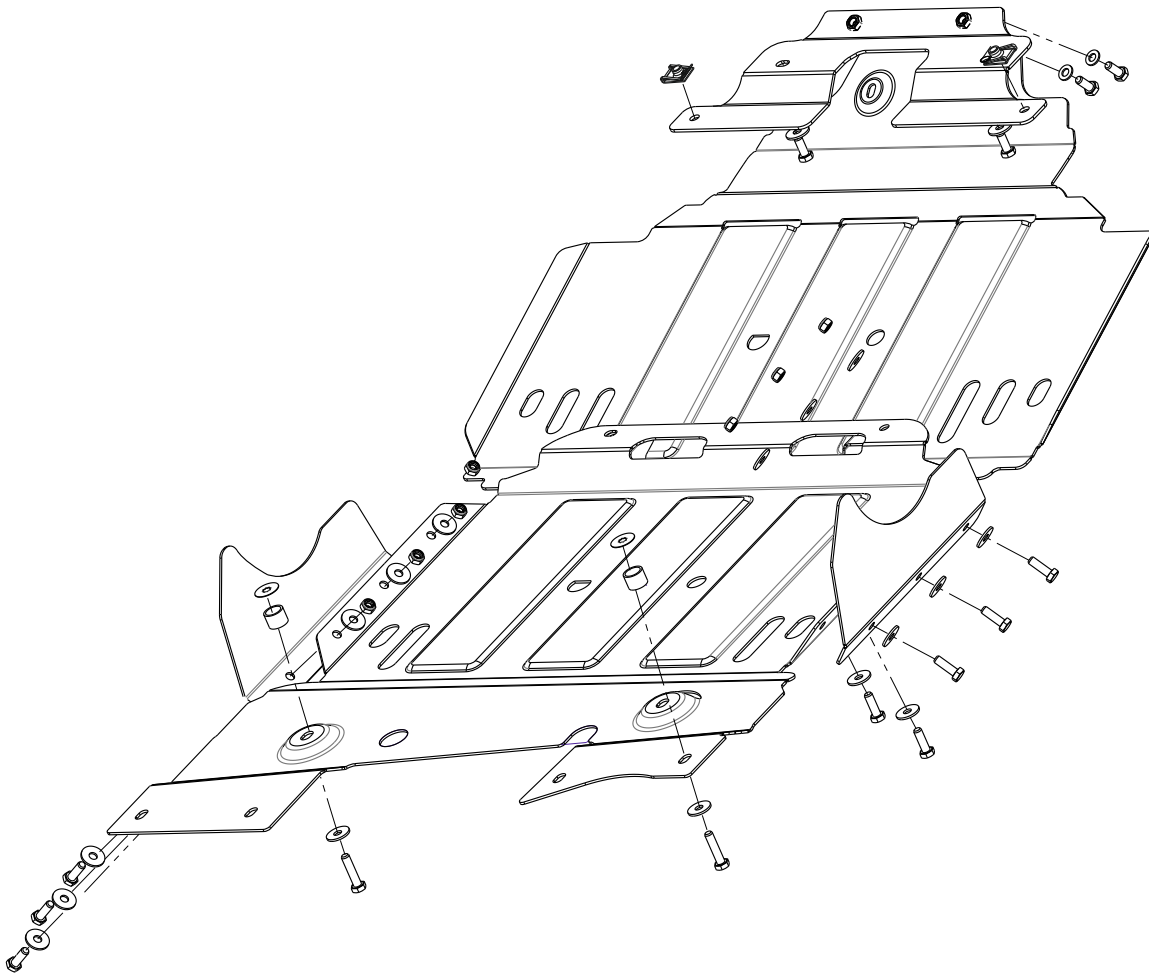

RU Движение
GB Movement Arrow

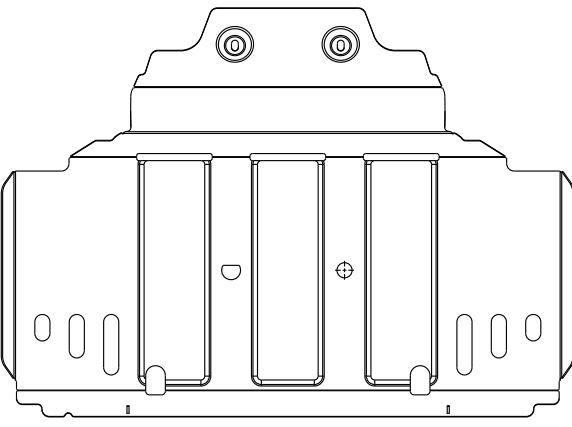
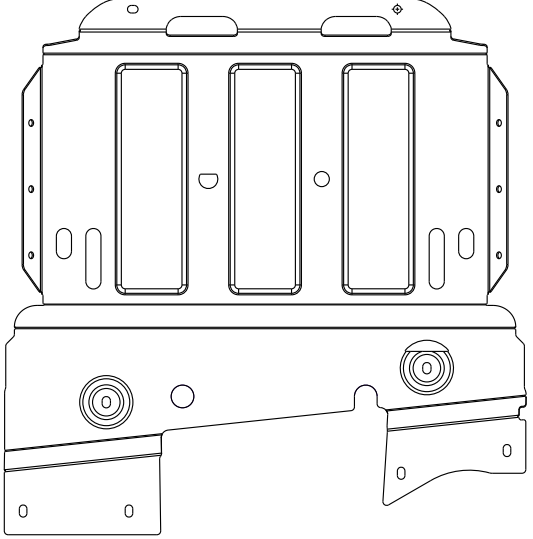
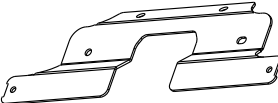

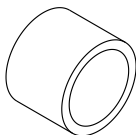
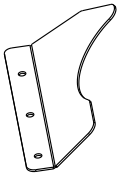
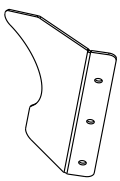
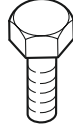
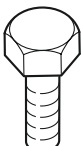
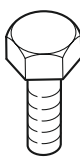
RU Поворот
GB Screw Arrow

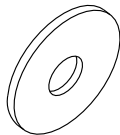
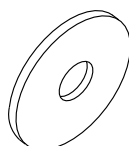

A  1X	B  1X			
C  1x	D  2X			
E  2x	F  1x			
G  1x	H  M8x20 4x			
I  M8x25 8X	J  M8x35 2X			
K  d=8 6X	L  d=8 2X			
M  d=8 2X	N  d=8 18X			
 MP	24.5031/24.5032		28/10/21	3/7

1

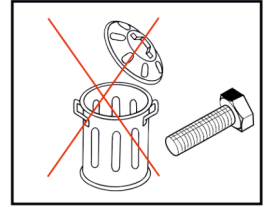
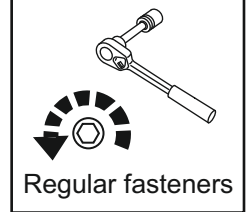
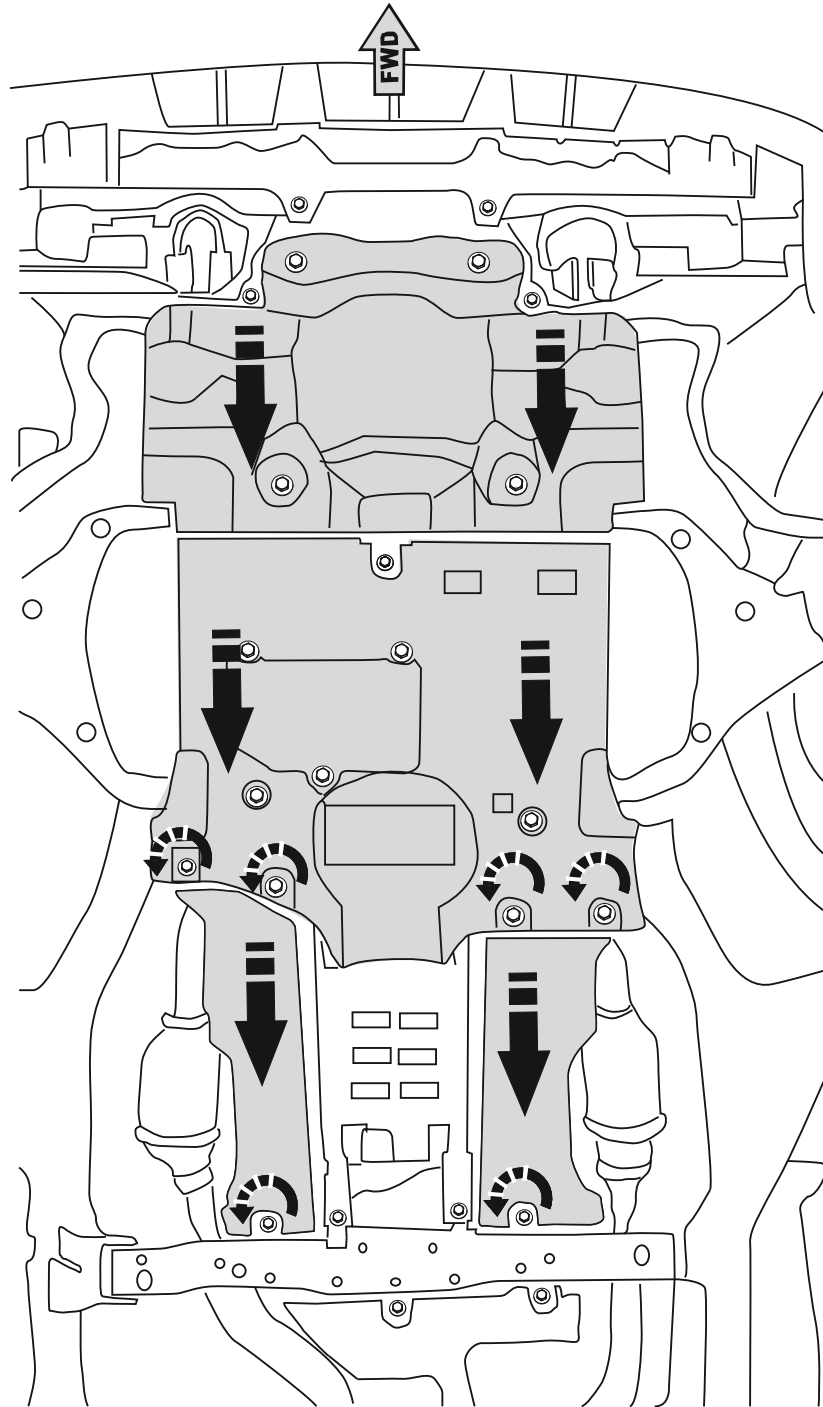

2

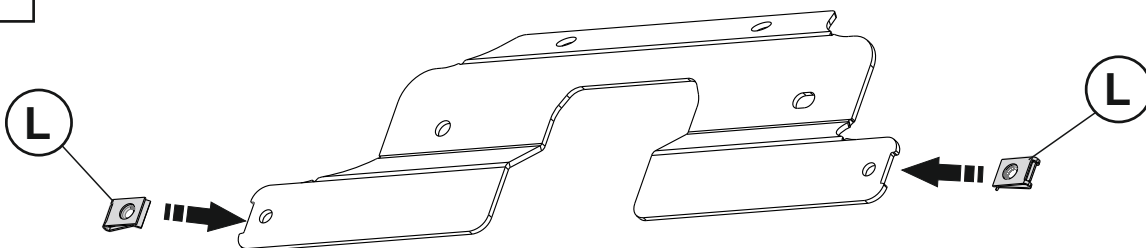

3

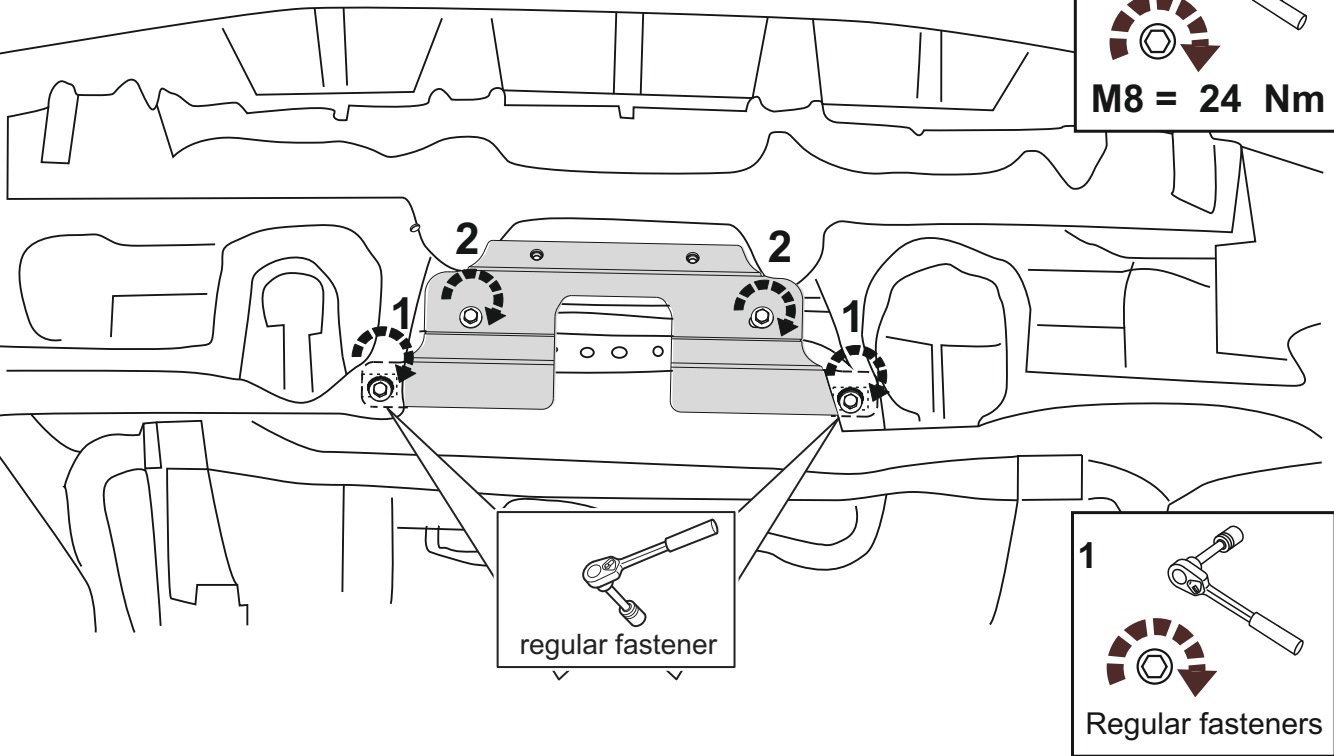
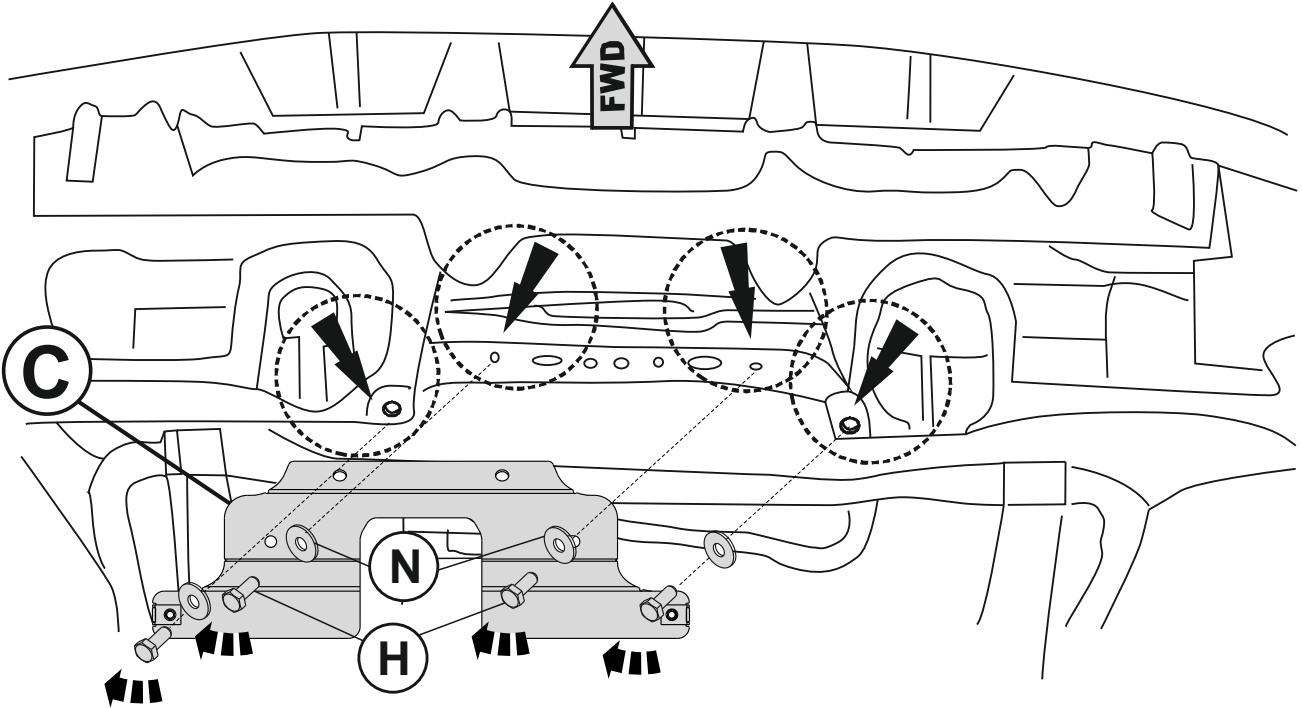

4

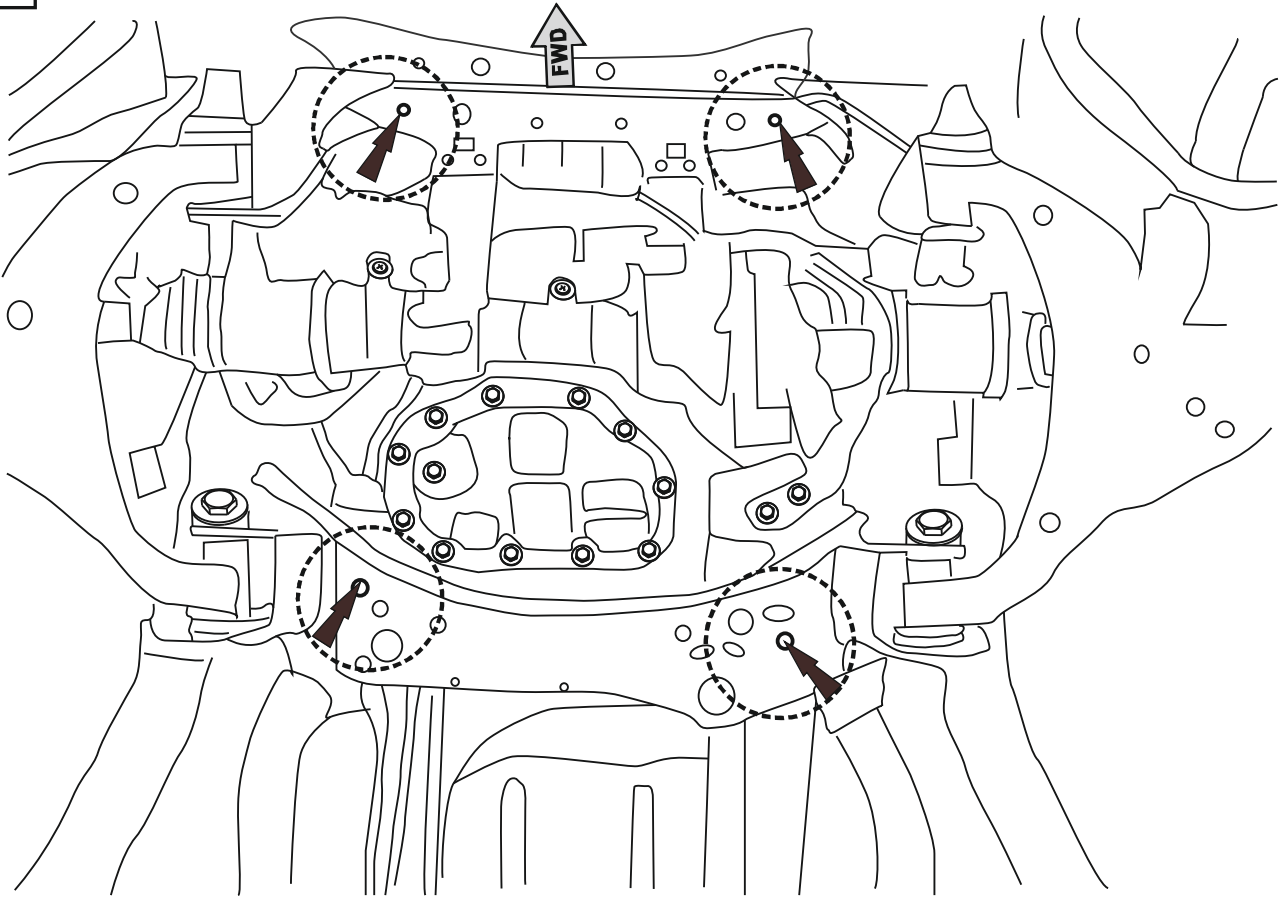

5

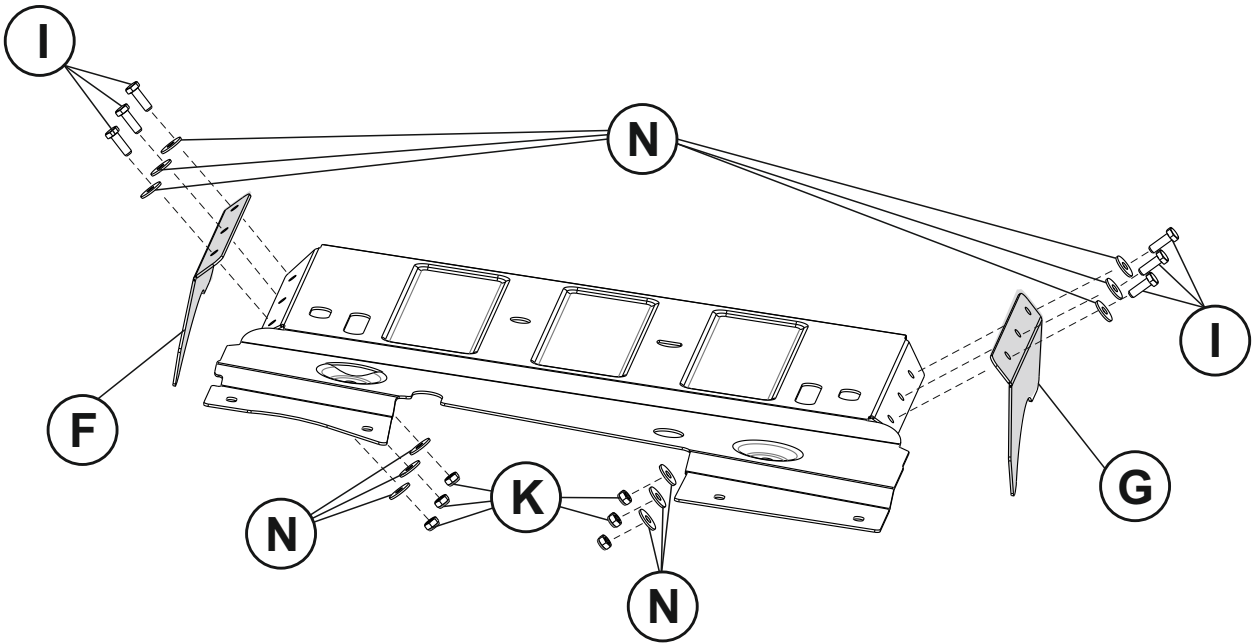

6

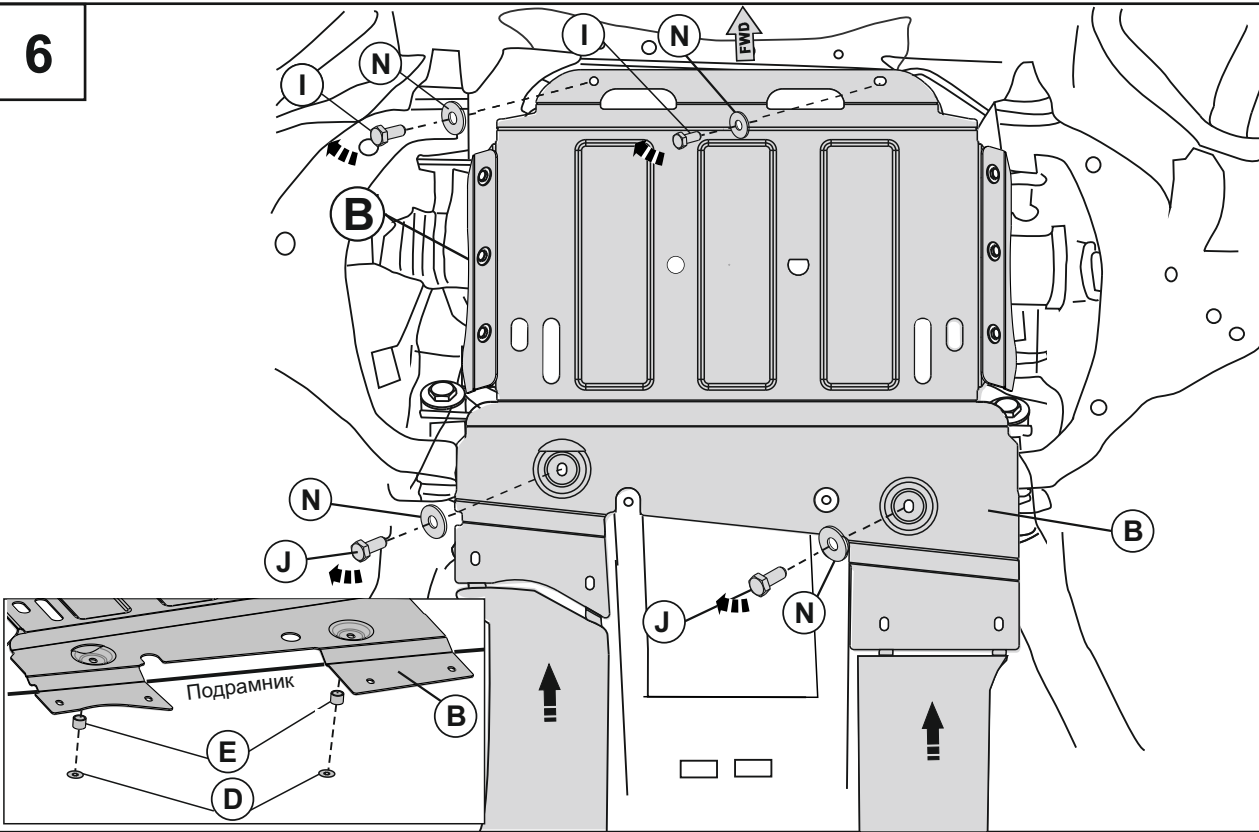

7

